



Buba PRO

User Manual

Your Buba PRO Diffuser Lamp

Welcome to your new Buba PRO. Please read this manual before operating your Buba PRO and keep it for future reference.

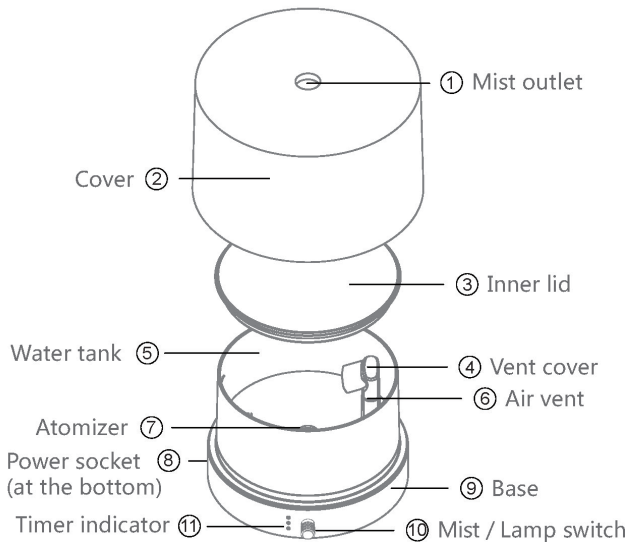

Getting Started

1. Remove the cover.

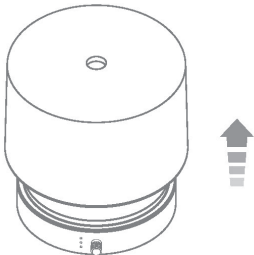

2. Remove the inner lid.

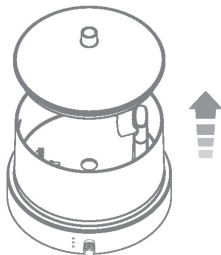

3. Fill the water tank to or below MAX water mark level.

- ⚠ Never fill water exceeding its maximum water mark level. Otherwise mist will not be generated properly.
- ⚠ Never add water around air vent.

MAX water level

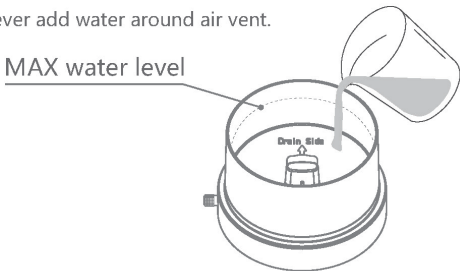

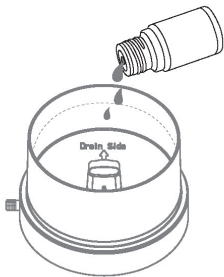

4. Add 5-10 drops of natural essential oil into the water tank.

⚠ Be sure to use extract pure essential oils 100% from natural ingredients. To avoid damage to this device, NEVER use artificially produced synthetic perfume.

5. Cover the inner lid and the cover.

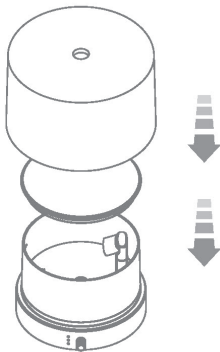

6. Plug the head of power adaptor into the power jack at the bottom of base and plug the power adaptor into the wall socket.



Mist and Timer Setting

Timer Setting

1st click always on mist	☀ ☀ ☀
2nd click 1 hour mist	☀ ○ ○
3rd click 3 hour mist	○ ☀ ○
4th click 8 hour mist	○ ○ ☀
5th click turn off mist	○ ○ ○



Mist Mode Setting

To switch between 2 mist mode, please press switch for 2 seconds until indicator blinks:



Press for 2s

Intermittent mist
(30 sec. on /30 sec. off)



Continuous mist

Note: Timer is not interrupted whenever mist mode is changed.
The Mist Mode will be restored to Continuous Mode when the power of unit is disconnected.

Light Switch and Dimming

Rotate the button clockwise to turn ON the lamp and increase brightness.

Rotate the button anticlockwise to decrease brightness and turn OFF the lamp.

Sleep Helper

Sleep Helper mode is lamp timer function tailored to turn off lamp gently in 30 minutes.

To activate, push down the button and rotate it either clockwise or anticlockwise. 3 indicators will flash once one by one from top to bottom.

To deactivate, push down the button and rotate it either clockwise or anticlockwise. 3 indicators will flash once one by one from bottom to top.

Note: Sleep Helper function is still active when brightness is adjusted even when the function is already activated. Once activated, Sleep Helper function remains, despite any other Timer Setting.

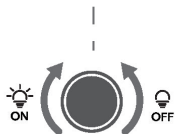

Turn ON/OFF Lamp

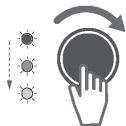

Activate Sleep Helper

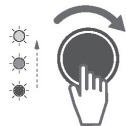

Deactive Sleep Helper



Disable Independent Lamp Mode

By default, Buba PRO PRO' s lamp works completely independent of "Timer" and "Auto Shutoff" functions. However, you can still set the lamp to switch off together with mist when "Timer" or "Auto Shutoff" function is activated, if needed.

Disable Independent Night Light

To disable Independent Light, push the button for 6 seconds. All 3 indicators flash together after 2 seconds and keep the button pressed until "1H" and "3H" indicators blink alternately 3 times.

Enable Independent Night Light Again

To enable, please repeat the same operation until you see "3H" and "8H" indicators blink alternately 3 times..



Press for 6s

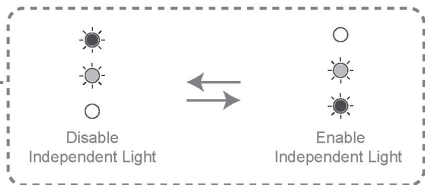

Note: The lamp will be restored to Independent Mode when the power of unit is disconnected.

Important Points You Must Know

- When water tank is empty, mist function will not be turned on.
- Water temperature, room temperature or humidity can affect the amount of mist resulting in shorter operating time.
- Due to water temperature or water quality, the amount of mist can be less at the beginning.
- Fragrance results may vary depending on ventilation, temperature, humidity, and the size of space
- NEVER empty the water from air vent side!

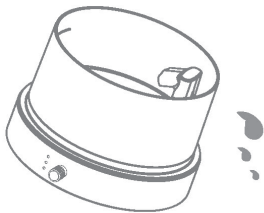
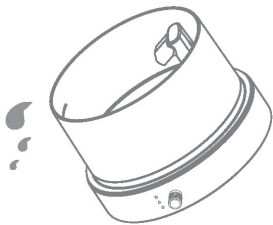

Maintenance

- The diffuser has an ultrasonic atomizer found in the center of water tank. Please clean the atomizer carefully using a cotton swab or a soft clean damp cloth at least once every week. You can clean the unit more often depends on your usage.
- NEVER apply aggressive force or shape object during cleaning process. Otherwise, the misting function can be damaged.
- Please make sure to unplug the adapter from the power outlet when cleaning.
- Empty and clean the water tank when not in use. If necessary, please only use kitchen detergent when cleaning.

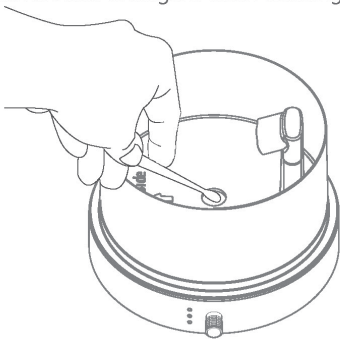

⚠ Accidental Leakage

In the event of the diffuser being knocked over or tipped during use, some water may get into the air vent. A drain hole at the base is designed to drain the water from the diffuser. Please follow below steps when there is leakage:

1. Unplug the head of adaptor from diffuser.
2. Remove the rest of water from water tank (avoid air vent side).
3. Lean the product towards the direction of water drain hole and drain the water from the hole.
4. Leave the product at a dry location for 24 hours.

Take below steps to avoid water leakage:

- Use measuring cup to add water.
- NEVER shake diffuser with water.
- DO NOT move diffuser with water.

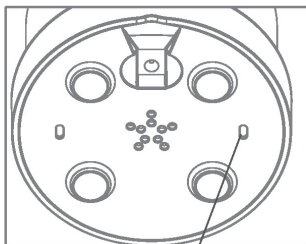
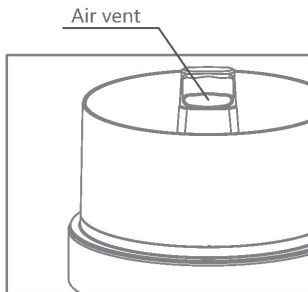

Water drain hole

Safety Precautions

- When the product is not in use for any extended periods of time, turn the unit off and remove the power supply.
- Always place the unit on a firm, flat surface. It is also recommended that you choose a surface that is protected from the possibility of water spills. Never place the device on carpet or flooring that can be damaged from coming into contact with moisture and wetness.
- DO NOT touch the unit if it has fallen into water. REMOVE POWER immediately.
- DO NOT place or drop the unit into water or any other liquid.
- Use the device only as described in this manual.
- NEVER drop, clog, or insert any objects into the opening.
- DO NOT Place the unit near any heat or combustible materials.
- ALWAYS keep the cord away from high temperature.
- NEVER USE outdoors. Your unit is rated for indoor use only.
- NEVER COVER the unit while it is operating.
- STOP using the product if the power cord or any parts of the unit are damaged.
- DO NOT attempt to repair or replace any parts in the unit.
- Should you notice an unusual sound or smell discontinue use immediately.
- Keep this unit out of reach of children.
- When the product is at the end of its life, we recommend disposal at a collection point for the recycling of electrical and electronic equipment, rather than with household waste.

Troubleshooting

Problem	Possible cause	Solutions
The mist function is not working	Power supplier is not connected	Plug the adapter into the power socket and press the mist button
	Insufficient water	Refill the water tank
Mist function is not working effectively	Too much water	Dump the excess water until water level is below MAX line
	Ultrasonic atomizer is clogged	Clean the atomizer according to the instructions in this manual
The mist ON indicator is on, the fan works, but no mist comes out	Some objects or water beneath the diffuser are blocking the air going into the vent underneath the diffuser	Remove the object(s) beneath the diffuser or clean the water underneath the diffuser.
	Water drip is blocking the air vent inside the water tank	Remove the air vent cover and clean the water on the top of air vent

Specifications

Model: M18

Atomization mode: Ultrasonic

Water tank capacity: 280ml (10.14 fl. oz.)

Power input: DC 24V, 12W

Mist Mode: Continuous/Intermittent

Product Size: 148*148*125mm (5.8"x5.8"x4.9")

Light Mode: Dimmerable / Sleep Timer

Timer Mode: 1H / 3H / 8H / ON

Working Time: up to 12 hours - continuous mode

up to 24 hours - intermittent mode

Accessories: Adaptor / Manual

Made in China

Patented Product



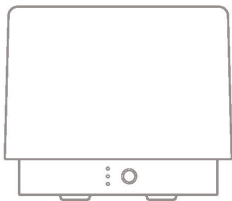

MT.19.1.25